

Data Sheet



Article number: 20252392

Description: E+G Clamping pad
GN 709.1-13-M8-R

Measures

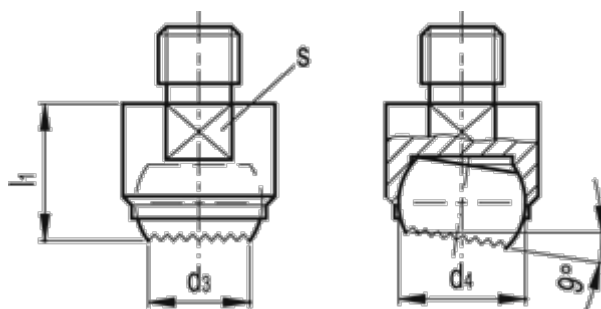

d1	= 13
d2	= M8
d3	= 7.2
d4	= 10
l1 +/-0.1	= 13
l2	= 8
Max static load (KN)	= 10
s	= 11

Weight (g) = 13